

COMPETITOR SERIES®

C-DD23-1-HC

C-DD48-2-HC

C-DD60-2-HC

C-DD72-3-HC

DIRECT DRAW BEER DISPENSER REFRIGERATORS

- Beautiful ergonomic appearance
- Digital temperature controller and read-out
- Black corrosion resistant steel exterior, stainless steel interior and stainless steel top
- Forced air refrigeration system
- Air tubes to refrigerate beer towers
- Side mount compressor
- Recessed door handles
- Leveling feet included
- Accessory: optional casters upon request
- All Natural R290 Hydrocarbon Refrigerant
- US Department of Energy Certified
- Migali® Protection Plan: 2 Year Parts & Labor Warranty, 5 Years Compressor Warranty

MODEL	DOORS	CAPACITY CU/FT	1/2 BARREL KEG CAPACITY*	BEER TOWERS INCLUDED	H/P	AMPS	VOLTAGE	PLUG TYPE	TEMP RANGE	EXTERIOR DIMENSIONS W X D X H**	INTERIOR DIMENSIONS W X D X H	PACKAGED DIMENSIONS W X D X H	WEIGHT	PACKAGED WEIGHT
C-DD23-1-HC	1	7.8	1	(1) double head	1/7+	1.92	115/60/1	Nema 5-15P	+33° F (-) +41° F	23.5 x 30.75 x 34.8	19.5 x 18.2 x 28.7	26 x 32.5 x 45	132 lbs.	176 lbs.
C-DD48-2-HC	2	13	2	(1) single head	1/5	3	115/60/1	Nema 5-15P	+33° F (-) +41° F	48.75 x 24.4 x 35.7	36.25 x 18.5 x 28.9	51.25 x 27.5 x 41.75	231 lbs.	275 lbs.
C-DD60-2-HC	2	17.3	2	(2) single head	1/5	3	115/60/1	Nema 5-15P	+33° F (-) +41° F	60.75 x 24.4 x 35.7	48.25 x 18.5 x 28.9	63.5 x 27.5 x 41.75	276 lbs.	319 lbs.
C-DD72-3-HC	3	21.6	3	(2) single head	1/3+	4	115/60/1	Nema 5-15P	+33° F (-) +41° F	72.8 x 24.4 x 35.7	60.2 x 18.5 x 28.9	75.25 x 27.5 x 41.75	331 lbs.	374 lbs.

* More combinations of keg types on spec sheet
 ** Height does not include draft tower

Accessories:

- Dual Head Beer Tower Part # 2481-233 (includes beer line and Sanky tap)
- Dual Head Beer Tower - CO2 gas tank and regulator are not included
- Caster - stem - with brake (5-3/4" overall) - Part Number 1597-01
- Caster - plate - with brake (5-1/4" overall) - Part Number 2481-329

FOR COMMERCIAL USE ONLY
NOTE: MIGALI® RESERVES THE RIGHT TO CHANGE SPECIFICATIONS WITHOUT NOTICE

TOLL FREE: 800.852.5292
WEB: www.migali.com

DIMENSIONAL DRAWINGS

C-DD23-1-HC

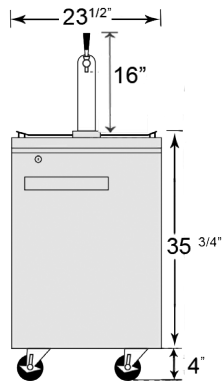

C-DD48-2-HC

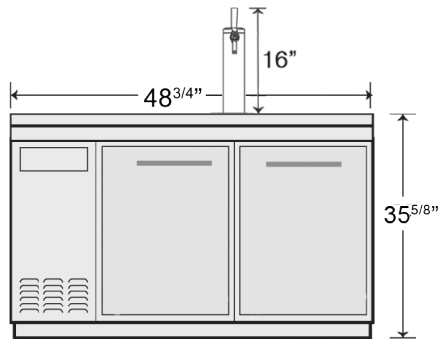

C-DD60-2-HC

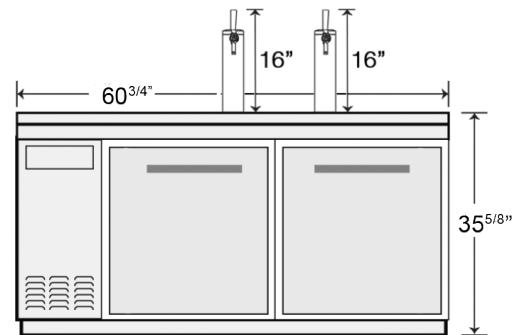

**C-DD23-1-HC
TOP VIEW**

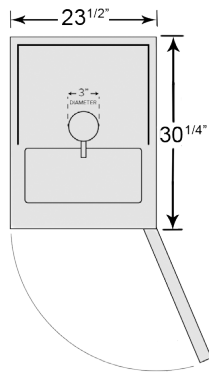

**C-DD48-2-HC
TOP VIEW**

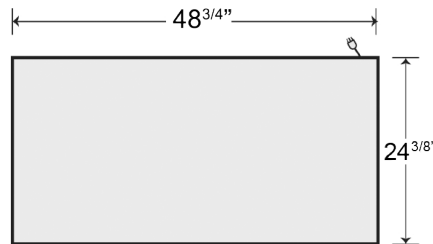

**C-DD60-2-HC
TOP VIEW**

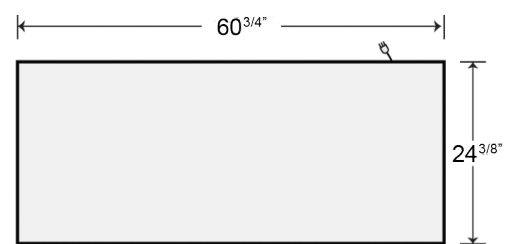

C-DD72-3-HC

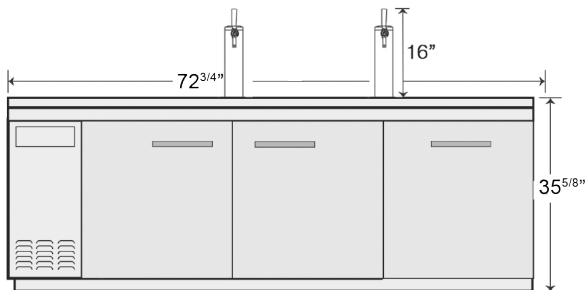

C-DD72-3-HC TOP VIEW

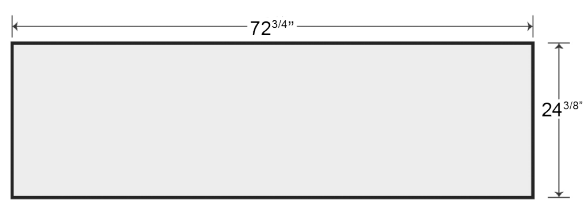

SIDE VIEW (1,2,3) DOOR MODELS

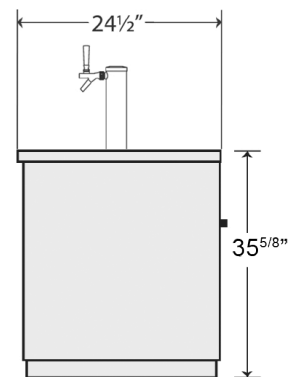

MIGALI® REMAINS AN AMERICAN FAMILY COMPANY SINCE 1955





COMPETITOR SERIES®

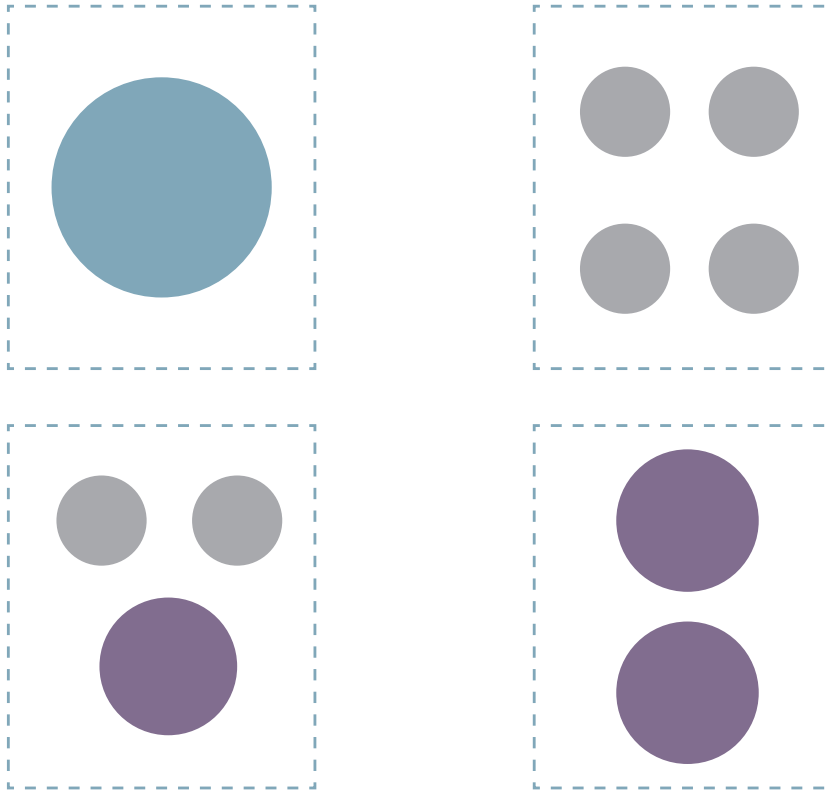

INSIDE CAPACITY FOR THE C-DD23-1-HC



KEG SIZE COLOR KEY

	STANDARD HALF KEG
	1/4 SLIM KEG
	1/6 KEG

NOTE: MIGALI® RESERVES THE RIGHT TO CHANGE SPECIFICATIONS WITHOUT NOTICE



TOLL FREE: 800.852.5292
WEB: www.migali.com





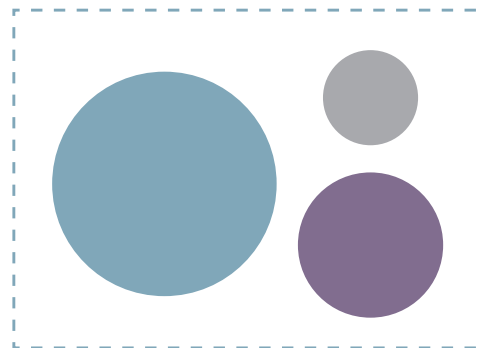
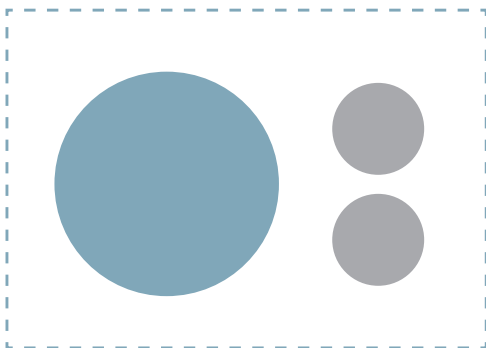
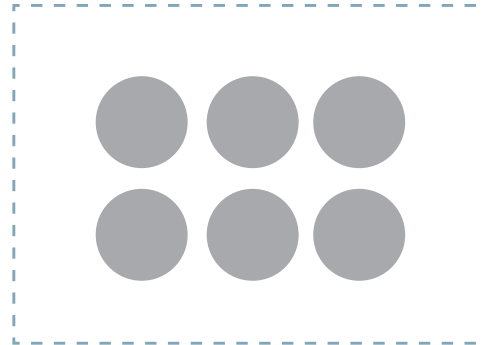
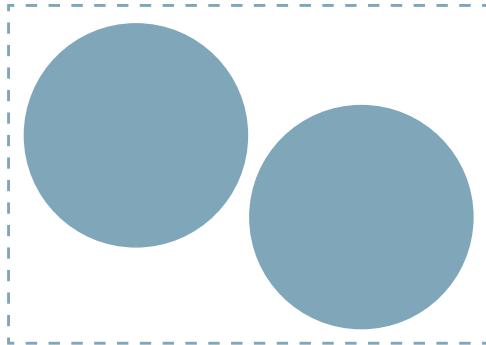

COMPETITOR SERIES®

INSIDE CAPACITY FOR THE C-DD48-2-HC



KEG SIZE COLOR KEY

-  STANDARD HALF KEG
-  1/4 SLIM KEG
-  1/6 KEG

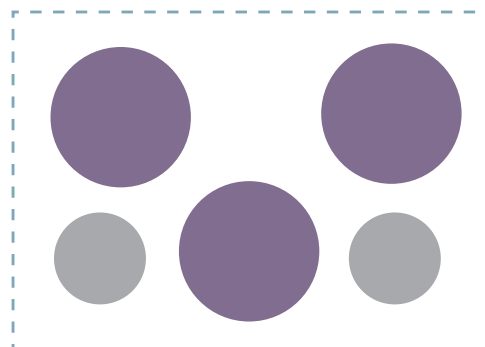

TOLL FREE: 800.852.5292
WEB: www.migali.com





Migali®



COMPETITOR SERIES®

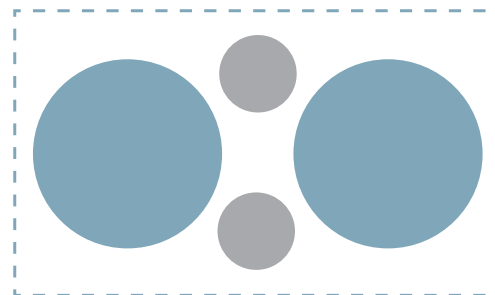
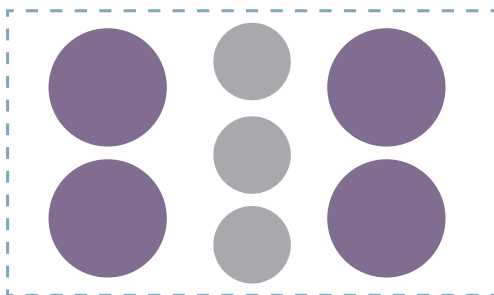
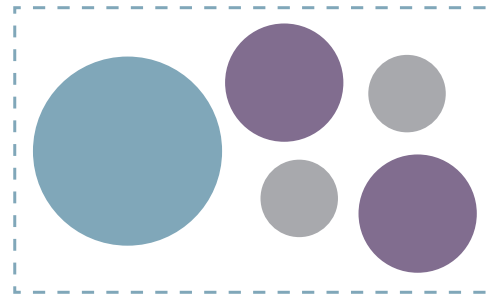
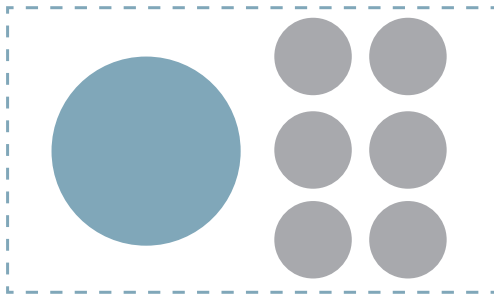
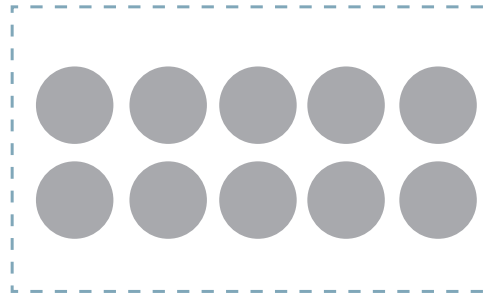
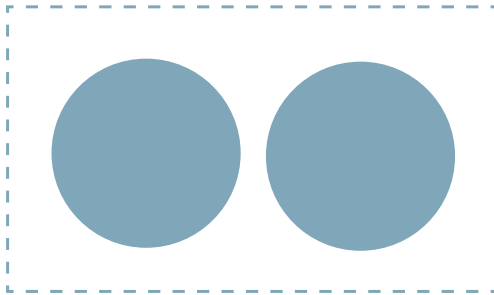

INSIDE CAPACITY FOR THE C-DD60-2-HC



KEG SIZE COLOR KEY

	STANDARD HALF KEG
	1/4 SLIM KEG
	1/6 KEG

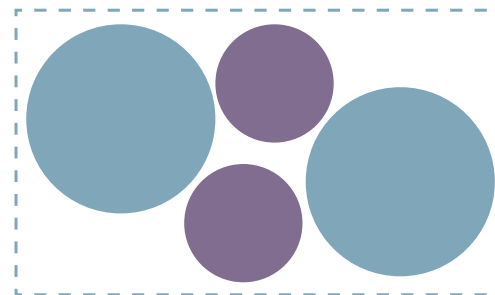

TOLL FREE: 800.852.5292
WEB: www.migali.com





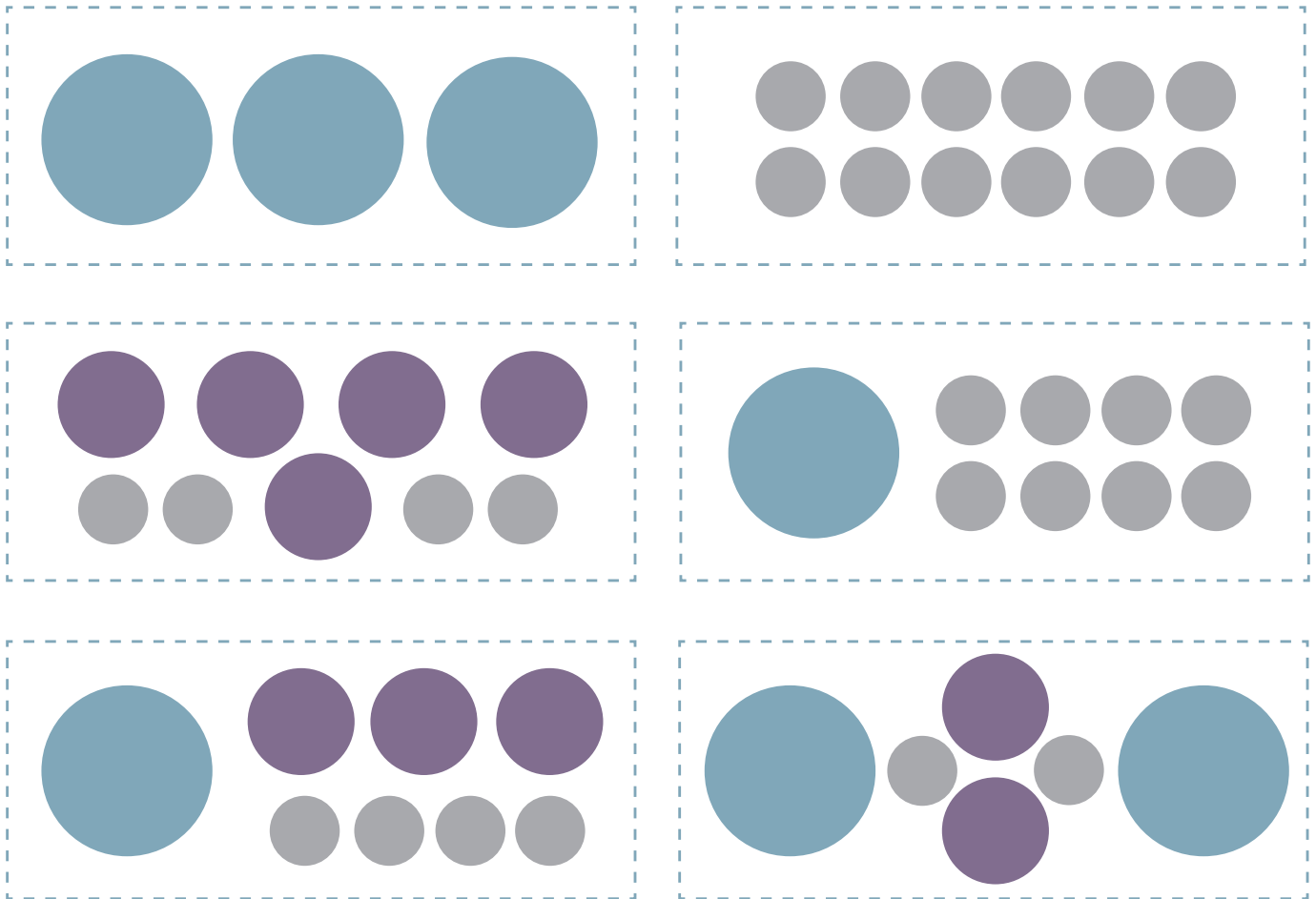

COMPETITOR SERIES®

INSIDE CAPACITY FOR THE C-DD72-3-HC



KEG SIZE COLOR KEY

	STANDARD HALF KEG
	1/4 SLIM KEG
	1/6 KEG



TOLL FREE: 800.852.5292
 WEB: www.migali.com

