

MAXIMIZER

Electric Bake & Roast Ovens

MODEL CE53BESC

Electric Bake/Roast Ovens can be combined with electric Pizza Ovens to meet your specific needs. Contact Peerless for details.

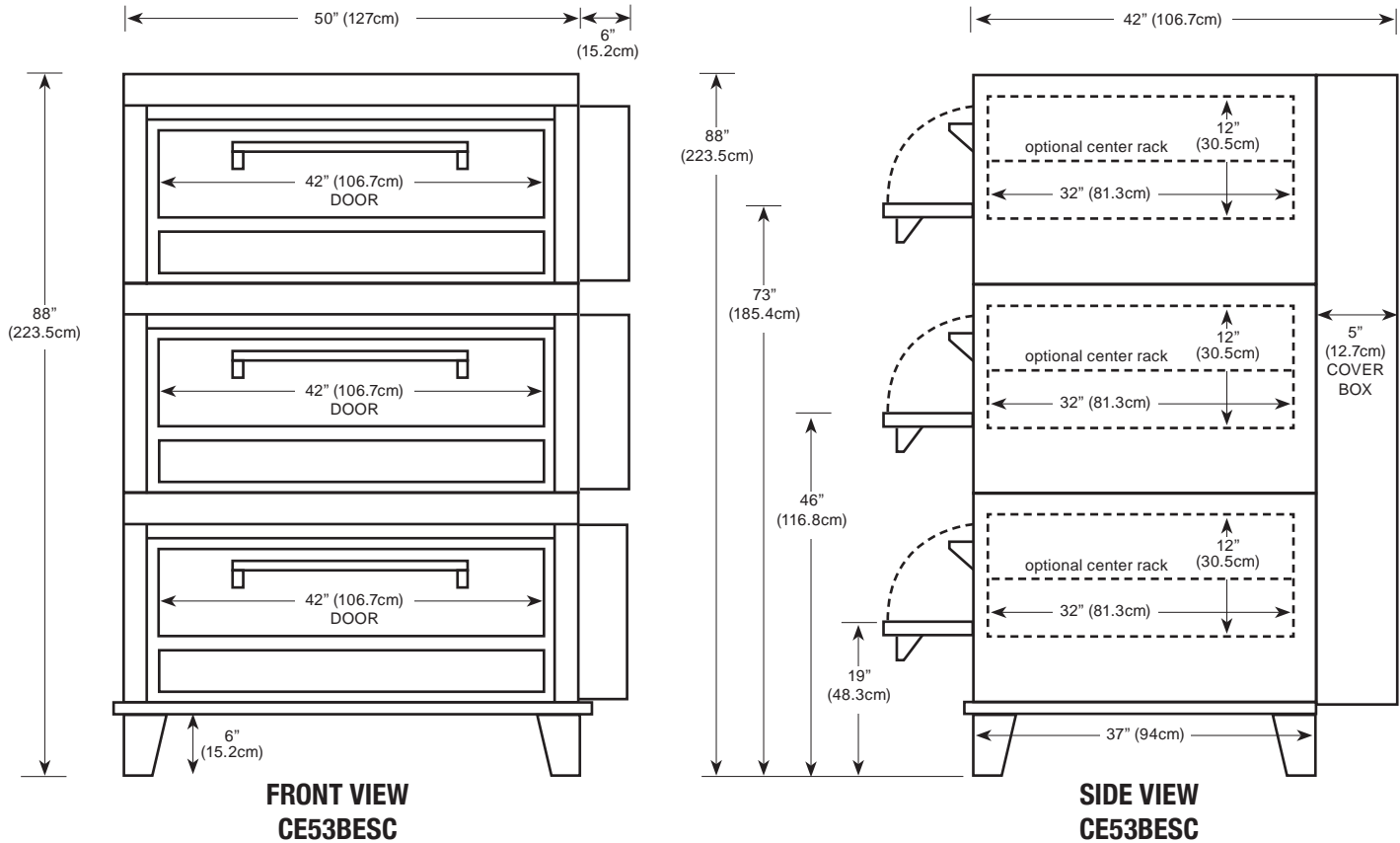

Floor space	56" (142.2cm) wide x 42" (106.7cm) deep* x 88" (223.5cm) high
Shelf size	42" (106.7cm) wide x 32" (81.3cm) deep x 12" (30.5cm) high
Shipping weight1650 lbs (748.4kg)
Capacity	Two 18"x26" bun pans per section
Electric	8 KW - 220V single phase, 50 AMPS each (3) Optional three phase, 30 AMPS each (3)
Maximum opening required for installation: 25"	* Handle adds 2.5"(6.4cm) to depth

