



America

www.BakeMax.com

Project: _____

Item: _____

Qty: _____ Date: _____

BakeMax America BACG Series Manual Gas Griddle

The BakeMax America BACG Series Manual Gas Griddle is designed to provide the ultimate performance and durability. As with all our heavy-duty countertop equipment, they are built to the highest commercial standards to ensure years of trouble-free service, featuring superior frame construction and stainless-steel exterior for easy maintenance. Combine all of this and our affordable prices and you have the best value for your budget.



Model # BACG24



Features

- Available in 15", 24", 36", 48" and 60" Widths.
- Stainless-Steel Construction
- Highly Polished 3/4" Steel Griddle Plate
- Easy-to-Light Pilots through the Front Panel
- Individual Burner Control with Individually Lit Pilots
- Enameled Burners, Designed to Achieve the Best Performance
- Each burner heats 12" of the Griddle Plate to Provide Even Heat Distribution
- Stainless Steel Splash Guard around the Griddle
- 4.4" Enameled Grease Tray for Easy Cleaning
- 3/4" Rear Gas Connection
- 4" Adjustable Stainless-Steel Legs
- LP Conversion Kit Included
- 2-Year Limited Warranty





Model # BACG60

** Due to continuous product improvement, specifications are subject to change without notice.

BakeMax® / Titan Ventures International Inc.

Warehouses:

20 Caribou St, Moncton, NB E1H 0P3 
5705 Valley Belt Rd Independence, OH 44131 
1201 E 27th Terrace Pittsburg, KS 66762 

Toll Free: 1-800-565-BAKE (2253)
Phone: 506-858-8990
Fax: 506- 859-6929
Email: Sales@BakeMax.com

BakeMax America BACG Series Manual Gas Griddle

Technical Information & Drawings

Model	Width	Depth	Height	Burners	BTU NG	BTU LP	Orifice #	
							Gas	LP
BACG15-1	15"	30.5"	16.85"	1	30,000	30,000	44	54
BACG24-2	24"	30.5"	16.85"	2	60,000	60,000	44	54
BACG36-3	36"	30.5"	16.85"	3	90,000	90,000	44	54
BACG48-4	48"	30.5"	16.85"	4	120,000	120,000	44	54
BACG60-5	60"	30.5"	16.85"	5	150,000	150,000	44	54

Shipping Information

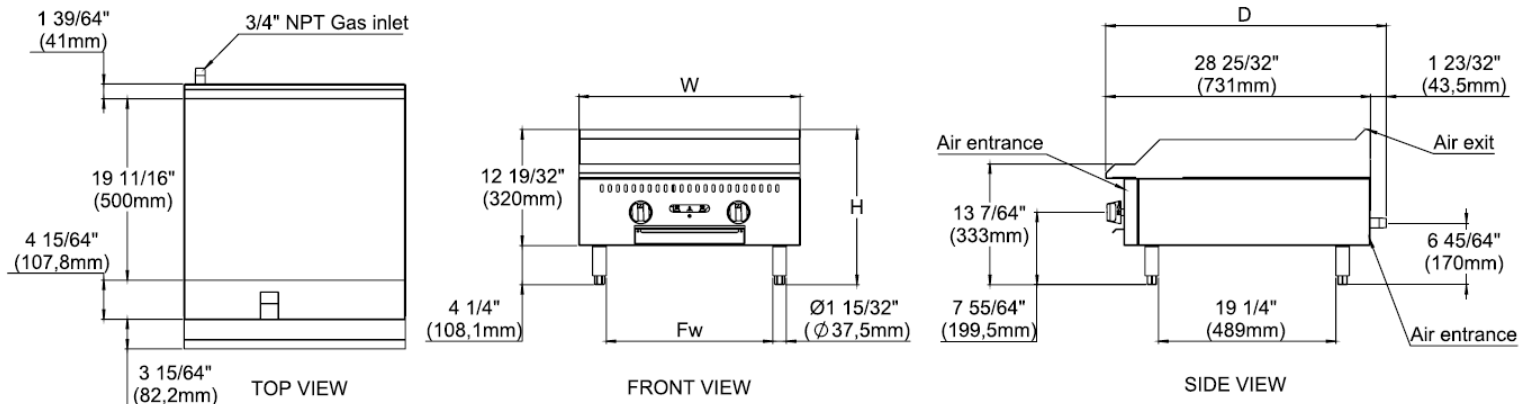

Model	Net Weight	Crated Weight	Crated Dimensions (W x D x H)
BACG15-1	140lbs. / 64kg	157lbs. / 71kg	23 x 34" x 19"
BACG24-2	182lbs. / 83kg	210lbs. / 95kg	29" x 34" x 19"
BACG36-3	240lbs. / 109kg	284lbs. / 129kg	40" x 34" x 19"
BACG48-4	258lbs. / 117kg	329lbs. / 149kg	52" x 34" x 19"
BACG60-5	315lbs. / 143kg	357lbs. / 162kg	64" x 34" x 19"



***Warning:** The minimum supply pressure on this appliance must be set at 4 water column inches for natural gas and 10 water column for propane gas. Each unit has a 3/4" gas connect at the rear of the appliance.

BakeMax[®] / Titan Ventures International Inc.

Warehouses:

20 Caribou St, Moncton, NB E1H 0P3 
 5705 Valley Belt Rd Independence, OH 44131 
 1201 E 27th Terrace Pittsburg, KS 66762 

Toll Free: 1-800-565-BAKE (2253)
Phone: 506-858-8990
Fax: 506- 859-6929
Email: Sales@BakeMax.com